

Features

- One-piece toilets integrate the tank and bowl into a seamless, easy-to-clean design.
- Compact elongated bowl offers added comfort while occupying the same space as a round-front bowl.
- Comfort Height® feature offers chair-height seating that makes sitting down and standing up easier for most adults.
- 1.28 gpf (4.8 lpf).
- Skirted trapway simplifies cleaning.
- Left-hand Polished Chrome trip lever.
- Glenbury™ Quiet-Close™ seat closes quietly and quickly unlatches from the toilet for easy removal and convenient cleaning.
- Patented ReadyLock™ installation system, a simple solution for skirted toilets, saves time, hassle, and eliminates the need to drill into the floor for standard 12" (305 mm) rough-in.
- Coordinates with other products in the Tresham collection.

Technology

- Single-flush gravity uses the force of gravity and a precision-engineered tank, bowl, and trapway to create a strong siphon during flushing.
- AquaPiston® canister allows water to flow into the bowl from all sides (360°), increasing the power and effectiveness of the flush.
- Flush valve's 3:2 ratio harnesses the natural force of gravity and optimizes flush performance.
- Durable canister design has 90% less exposed seal material than a 3" flapper for leak-free performance.
- Light-touch canister flush requires a lower actuation force than a flapper.

Installation

- Standard 12" (305 mm) rough-in.
- 10" and 14" (254 mm and 356 mm) rough-in kits also available.
- Supply line sold separately.

Water Conservation & Rebates

- Eligible for consumer rebates in some municipalities.

Recommended Products/Accessories

K-75796 Cachet® Nightlight Quiet-Close™ Elongated toilet seat
 K-4108 C³®-230 Elongated bidet toilet seat
 K-5381 14" Rough-in Full Skirt Trap and Attachment System
 K-5383 10" Rough-in Full Skirt Trap and Attachment System
 K-9375 Trip Lever
 1023457 Wax Ring/Hardware Kit
 1265114 Connector Hose
 K-23726 Drain treatment



ADA **CSA B651** **OBC**

Codes/Standards









ASME A112.19.2/CSA B45.1
 DOE - Energy Policy Act 1992
 EPA WaterSense®
 California Energy Commission (CEC)
 ADA
 ICC/ANSI A117.1
 CSA B651
 OBC

KOHLER® Toilets and Seats Limited Warranty

See website for detailed warranty information.

Available Colors/Finishes

Color tiles intended for reference only.

Color	Code	Description
	0	White
	96	Biscuit
	NY	Dune
	95	Ice™ Grey
	G9	Sandbar
	33	Mexican Sand™
	K4	Cashmere
	58	Thunder™ Grey
	7	Black Black™

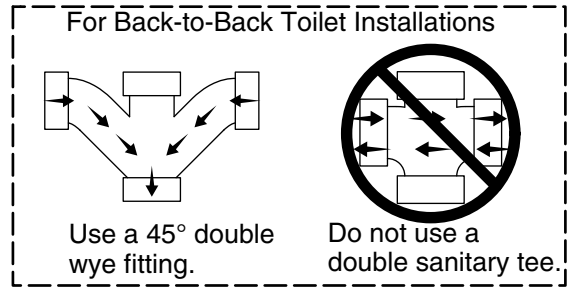
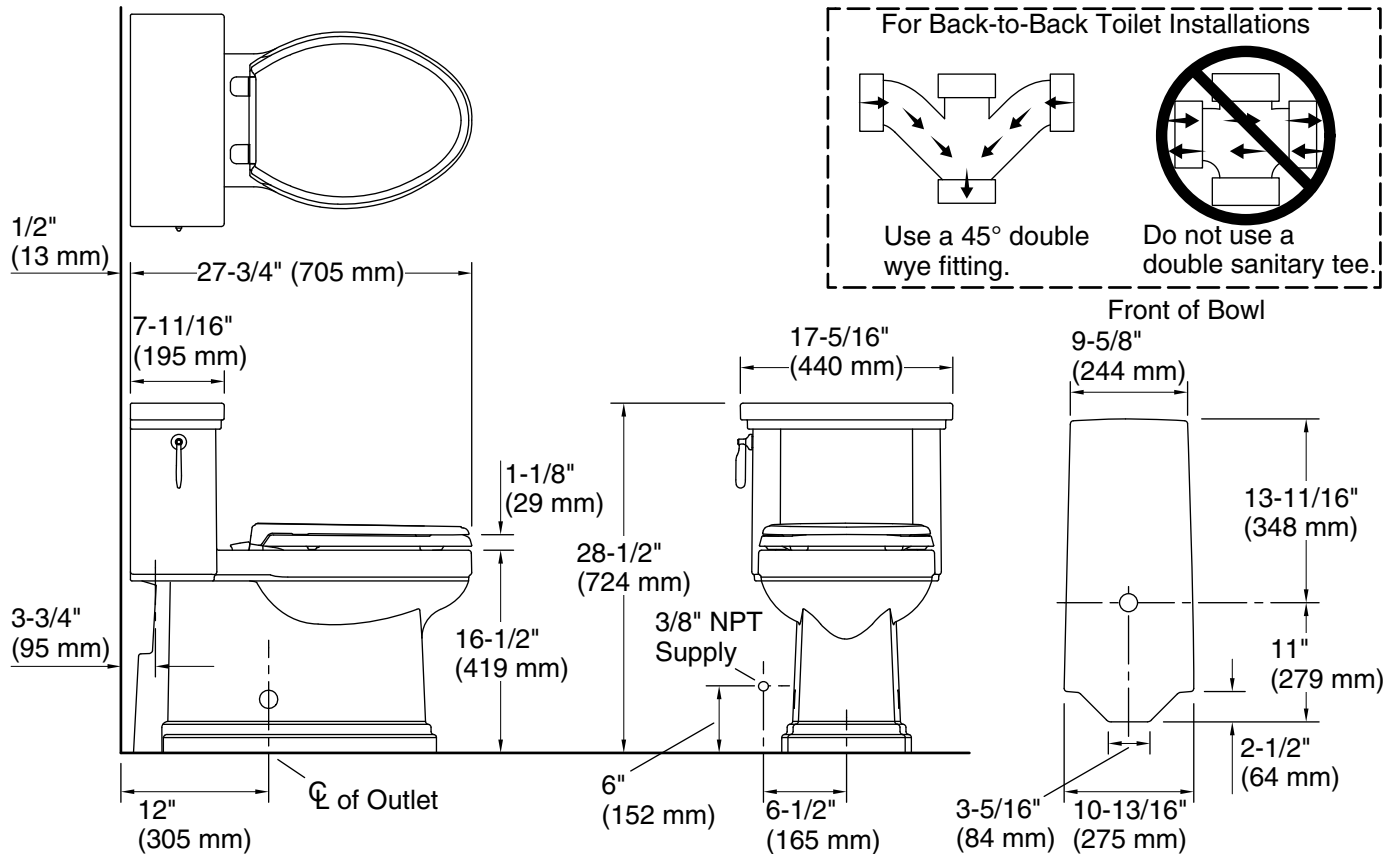

Technical Information

All product dimensions are nominal.

Toilet type:	One-piece, Floor-mount
Waste Outlet:	Floor
Bowl shape:	Compact elongated
Trap passageway:	2-1/8" (54 mm)
Water Consumption	
Full:	1.28 gpf (4.8 lpf)
Water surface size:	9-5/8" x 6-7/8" (245 mm x 174 mm)
Rim to water surface:	5-3/8" (137 mm)
Rough-in:	12" (305 mm)
Seat-mounting holes:	5-1/2" (140 mm)

Notes

Install this product according to the installation instructions.

For back-to-back toilet installations: Use only a 45° double wye fitting.

ADA, OBC, CSA B651 compliant when installed to the specific requirements of these regulations.

Plumbing codes may require elongated toilets and elongated, open-front seats in public bathrooms.

Accessibility standards may require controls to be located on the open side of the toilet.